

Article number: 201161VDEA1

Description: E+G Door lock GN 116.1-VDE-A1
VDE with double bit

Measures

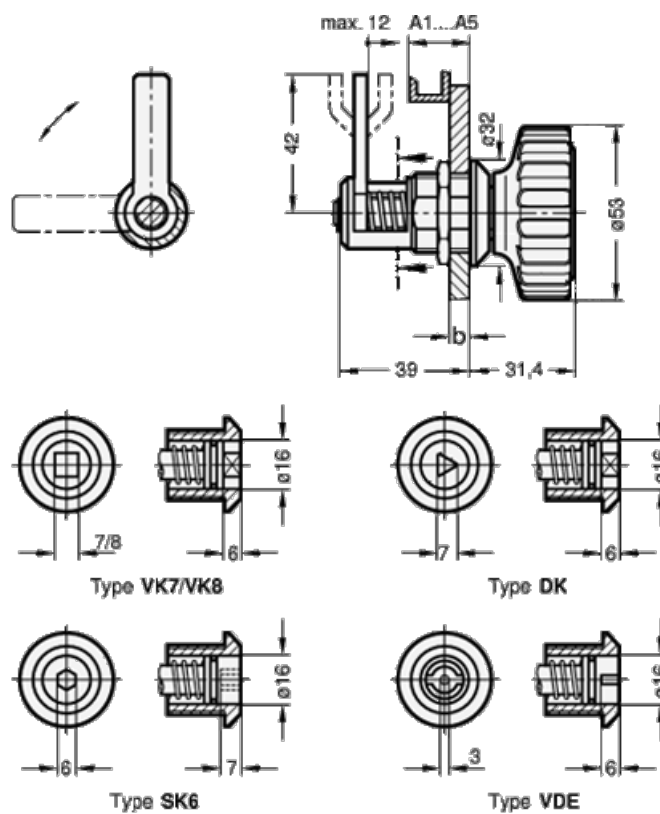

b max = 6
Door + frame thickness = 4-16